

EST. IV, 1

050.

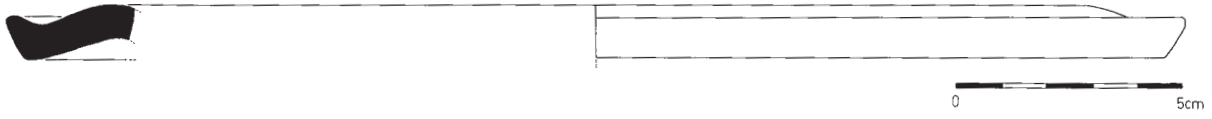

EST. IV, 2

012.

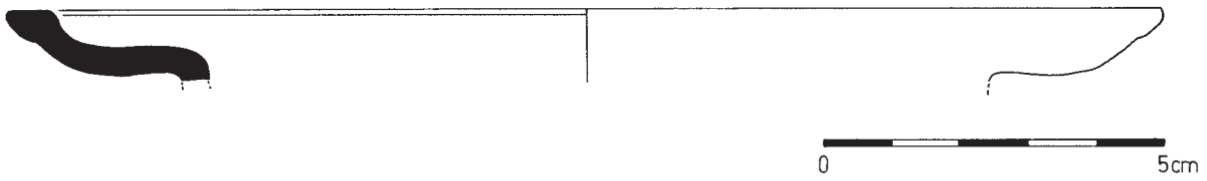

EST. IV, 3

028.



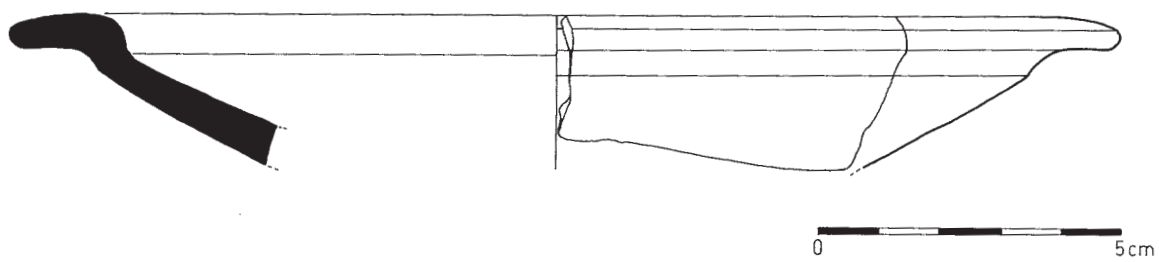
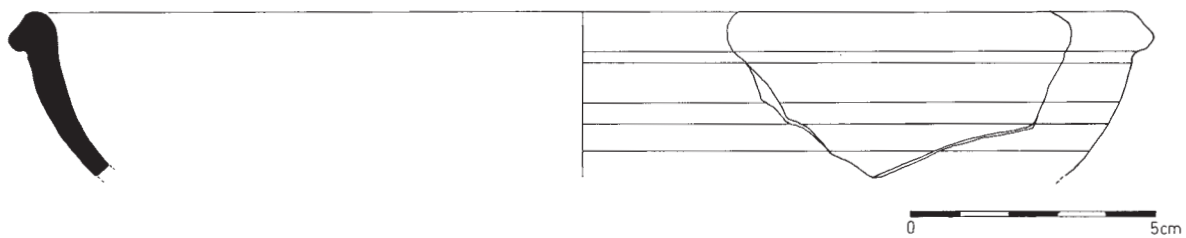

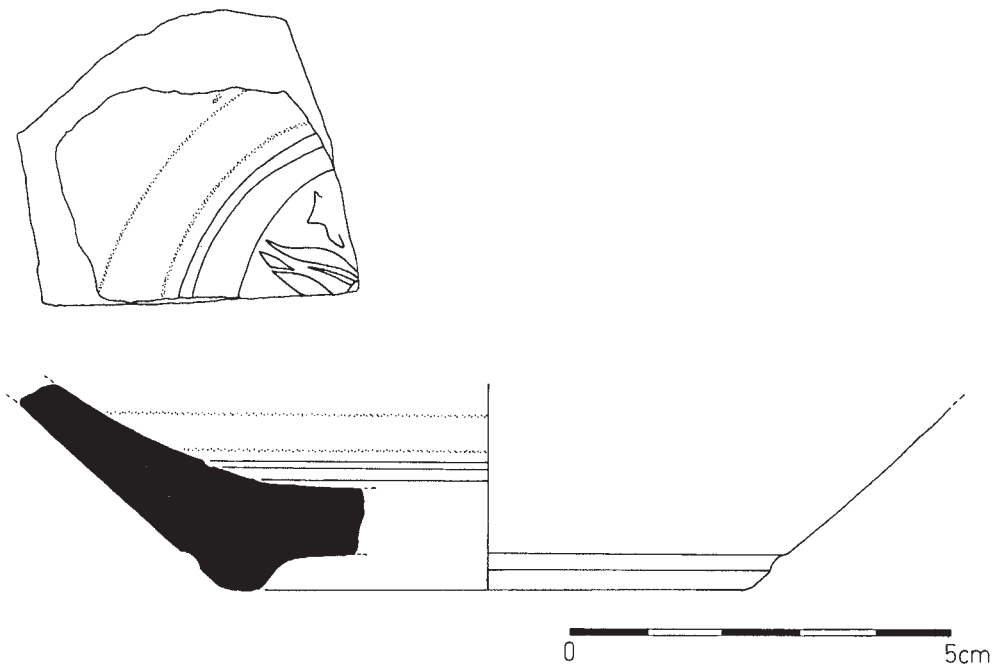
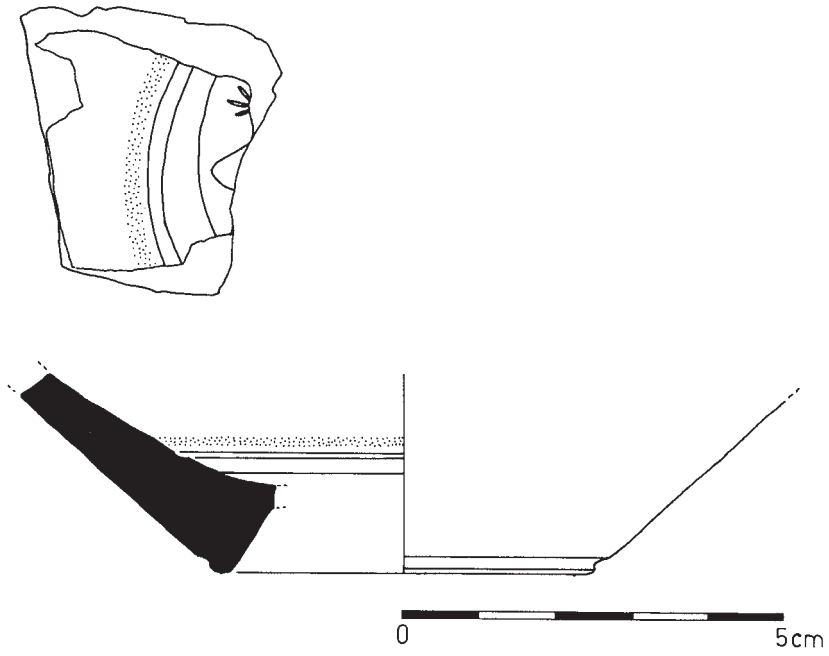

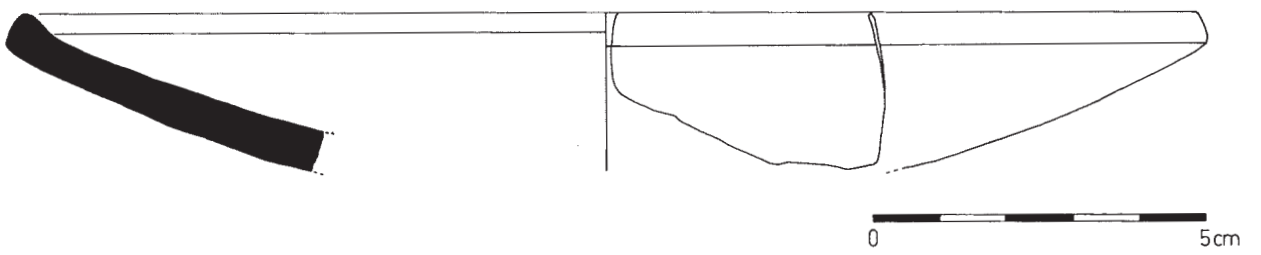
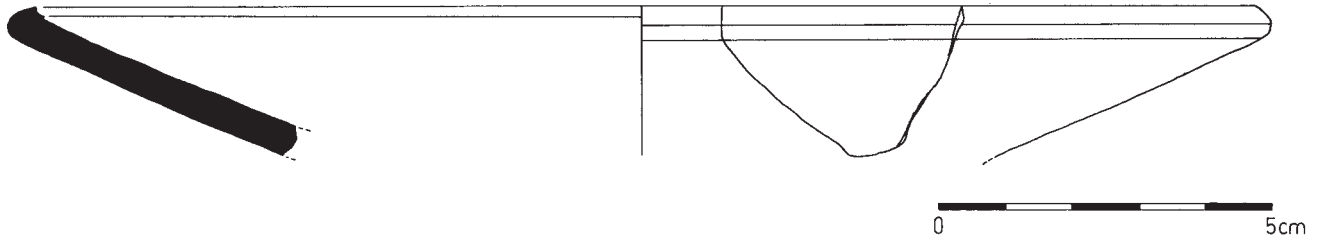



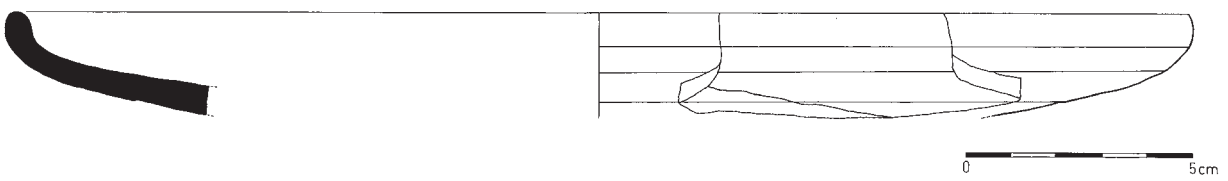
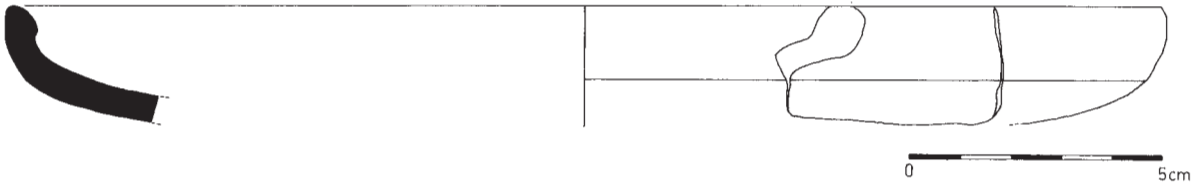

EST. IX, 1

oro.

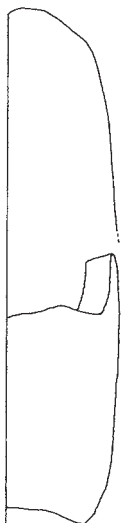

EST. IX, 2

oro.



EST. X, 1

011.

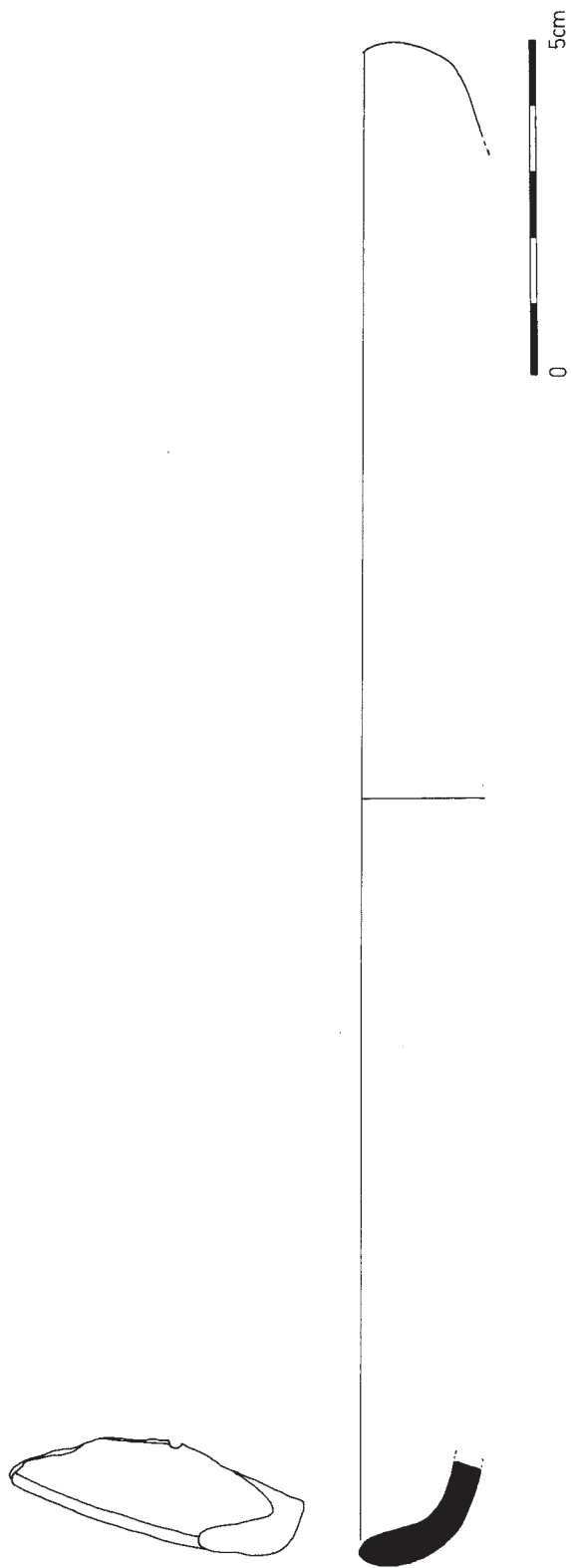

EST. X, 2

009.

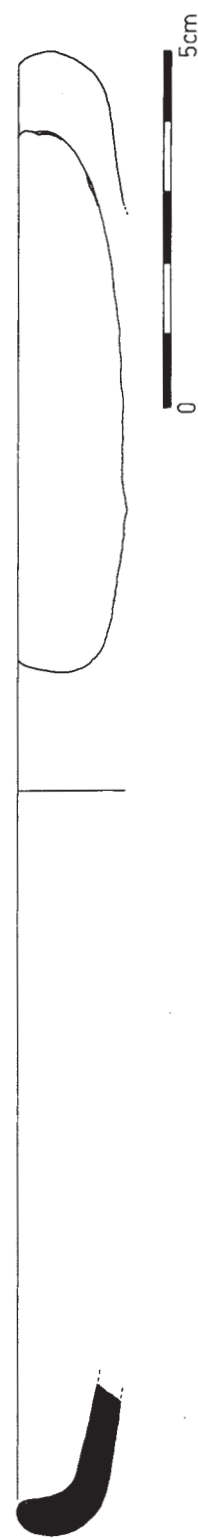

EST. XI, 1

018.

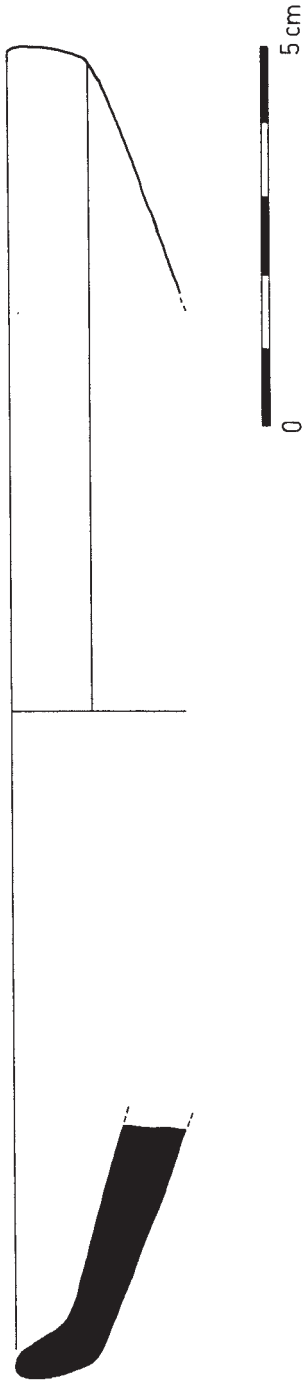

EST. XI, 2

020.

